

Ⅲ 特定施設編

1. 公園等

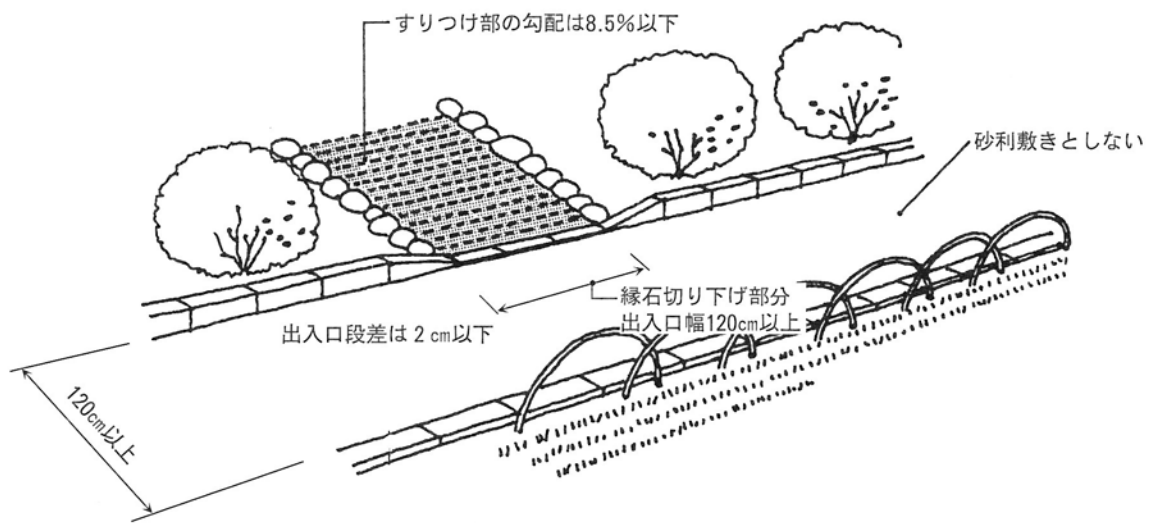

• ベンチの例

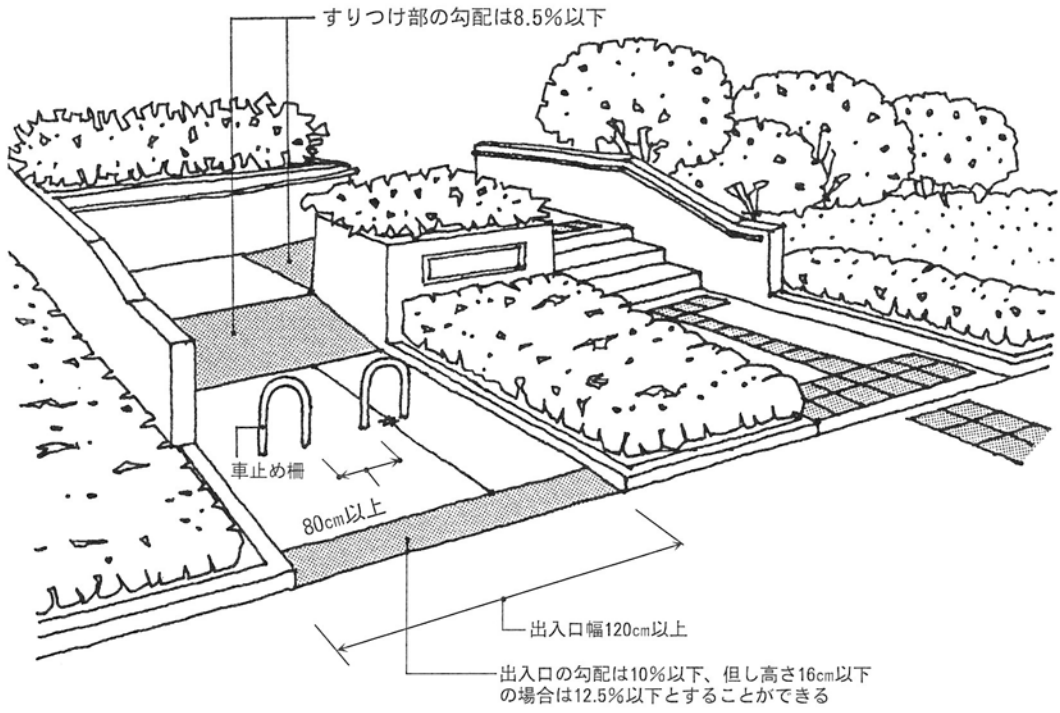
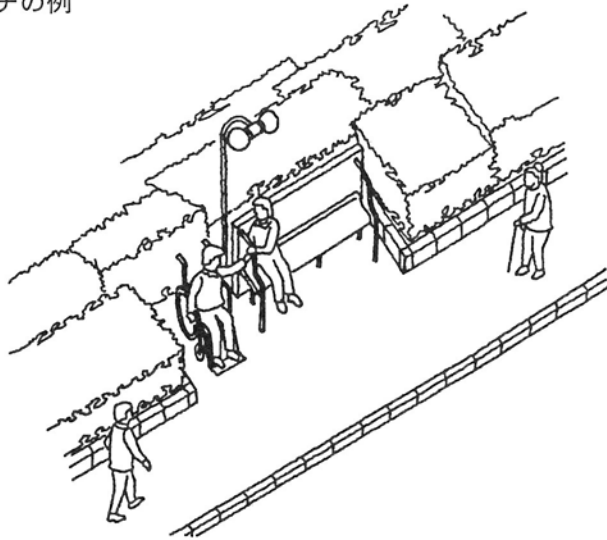

一般用ベンチの例

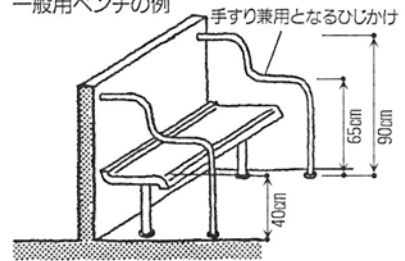

杖使用者用ベンチの例

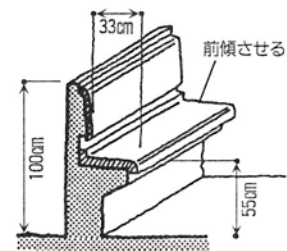

• 野外卓の例

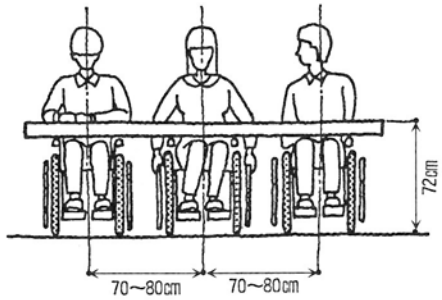
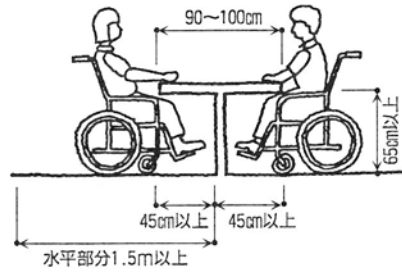
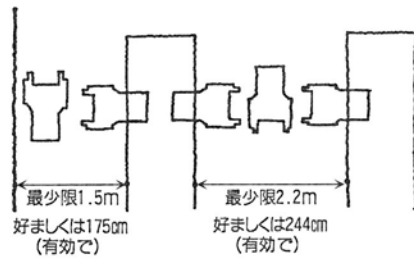

• 水飲み場の例



2. 道 路

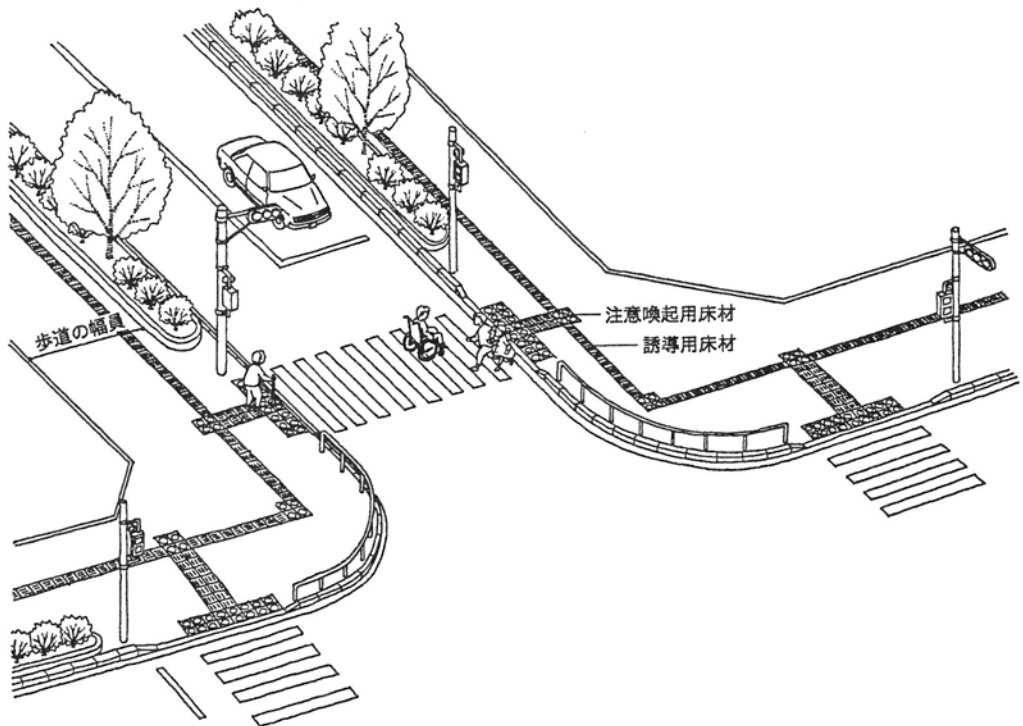

• 歩道と車道の分離方法

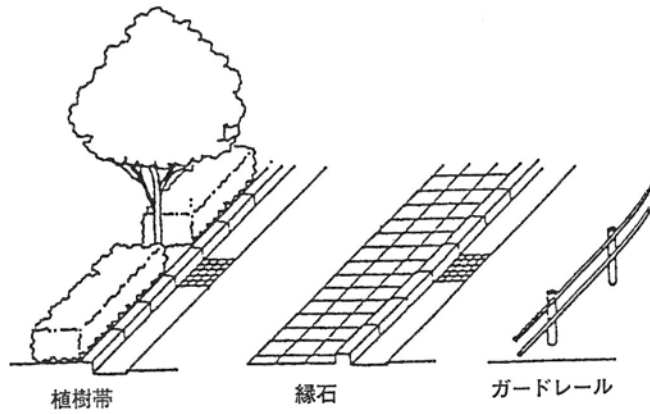

• 排水溝のふたの仕様

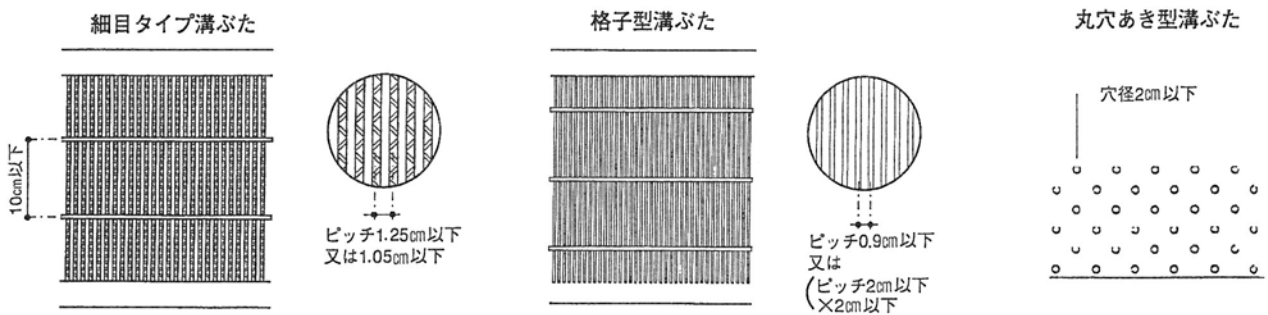

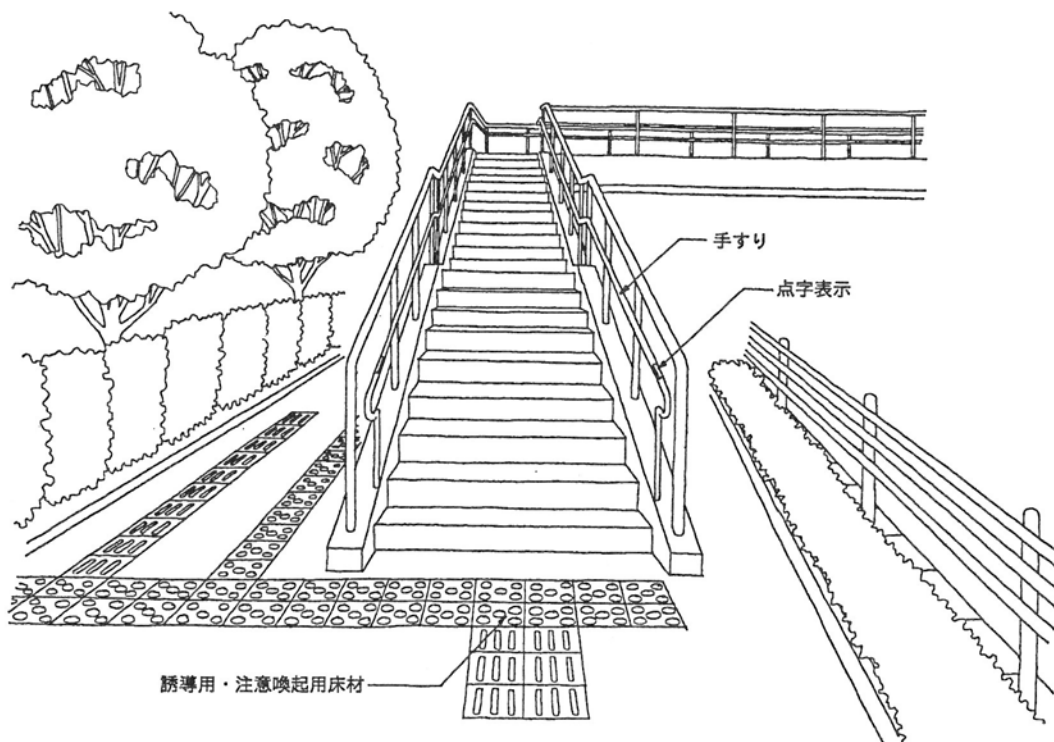

・手すりの点字表示

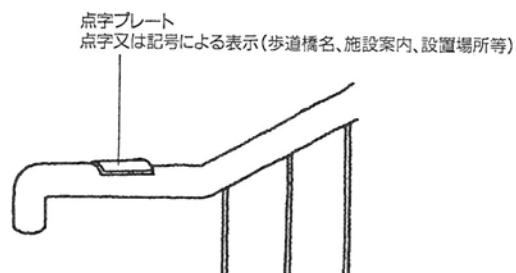

・階段の形状

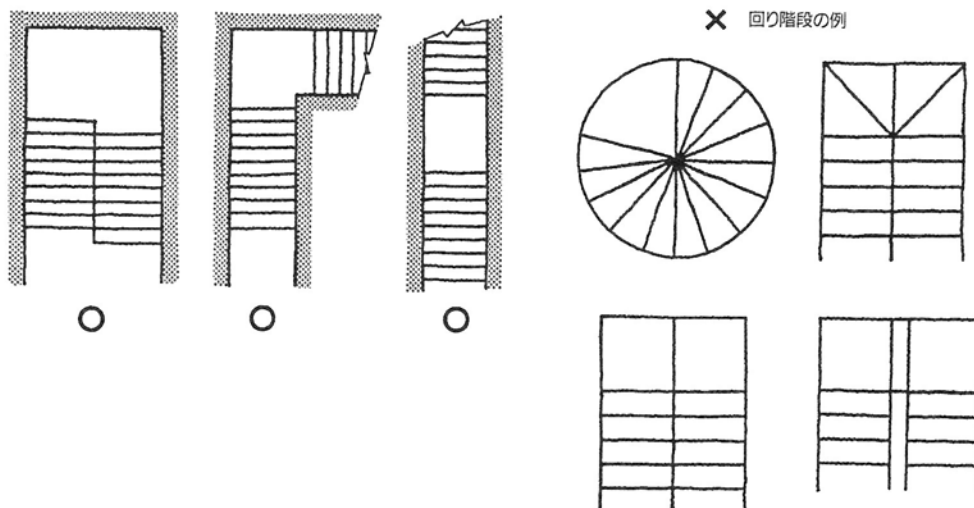

3. 建築物以外の公共交通機関の施設

• 乗降場

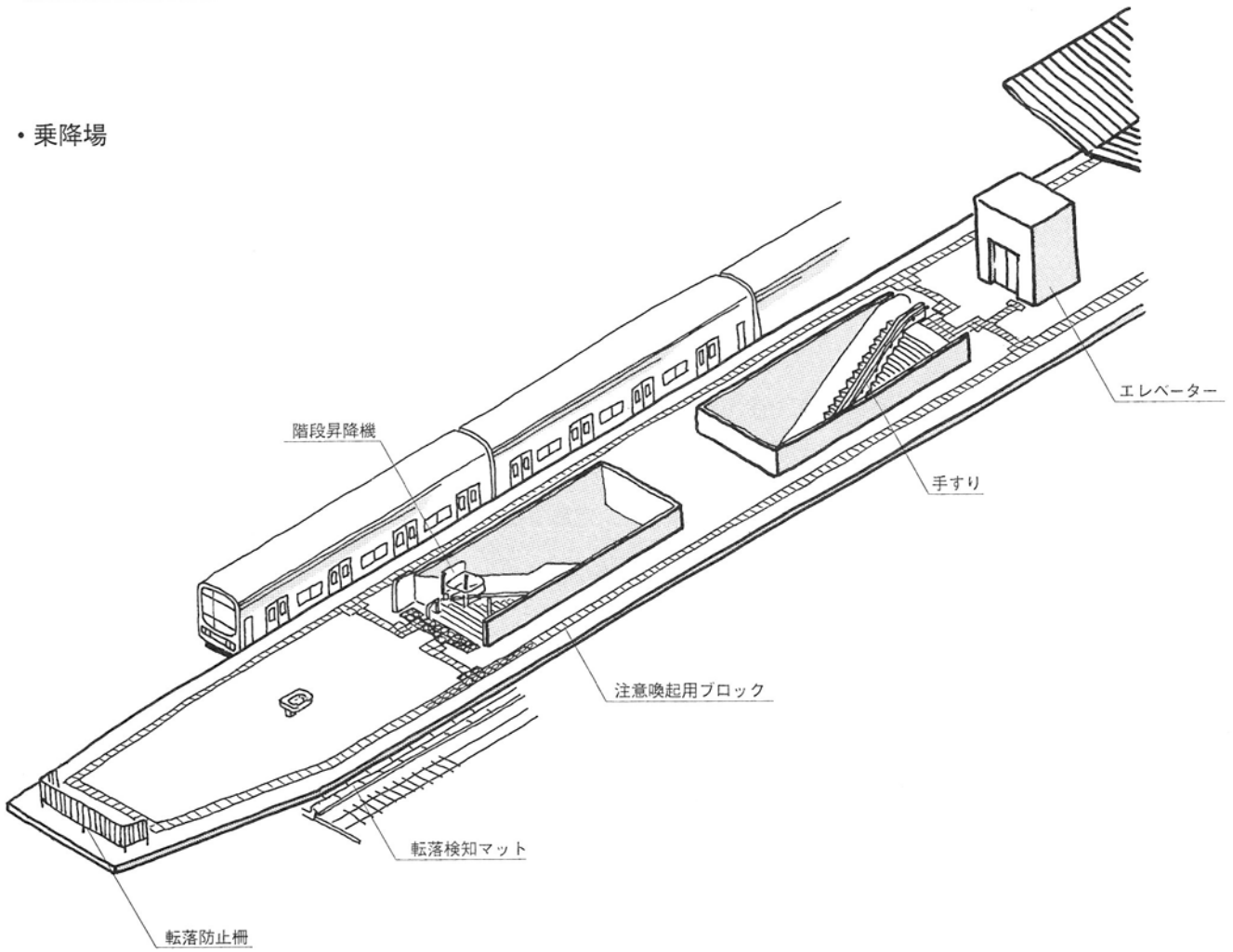

• ホーム階段表示

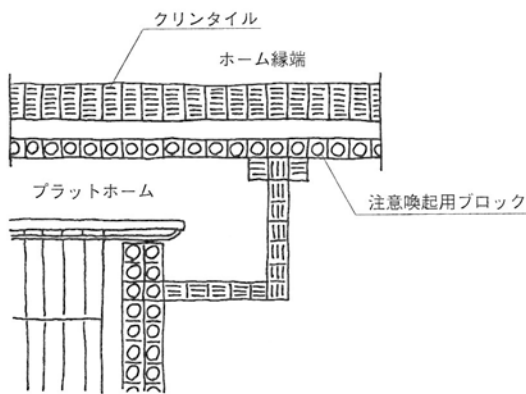

• ホーム縁端警告表示

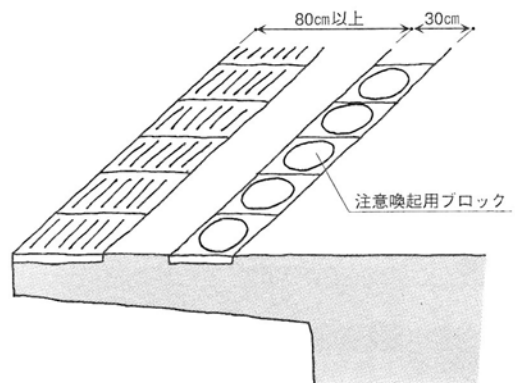

• エスカレーター表示

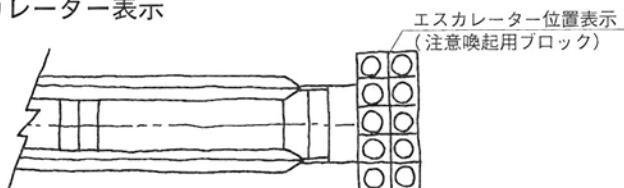

• 便 所

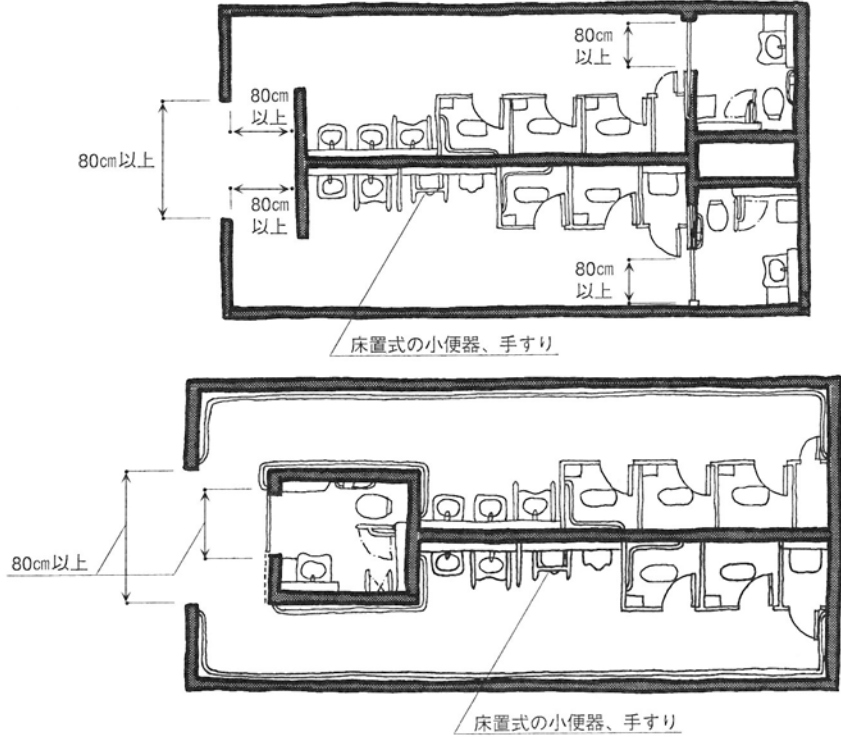

• 案内表示

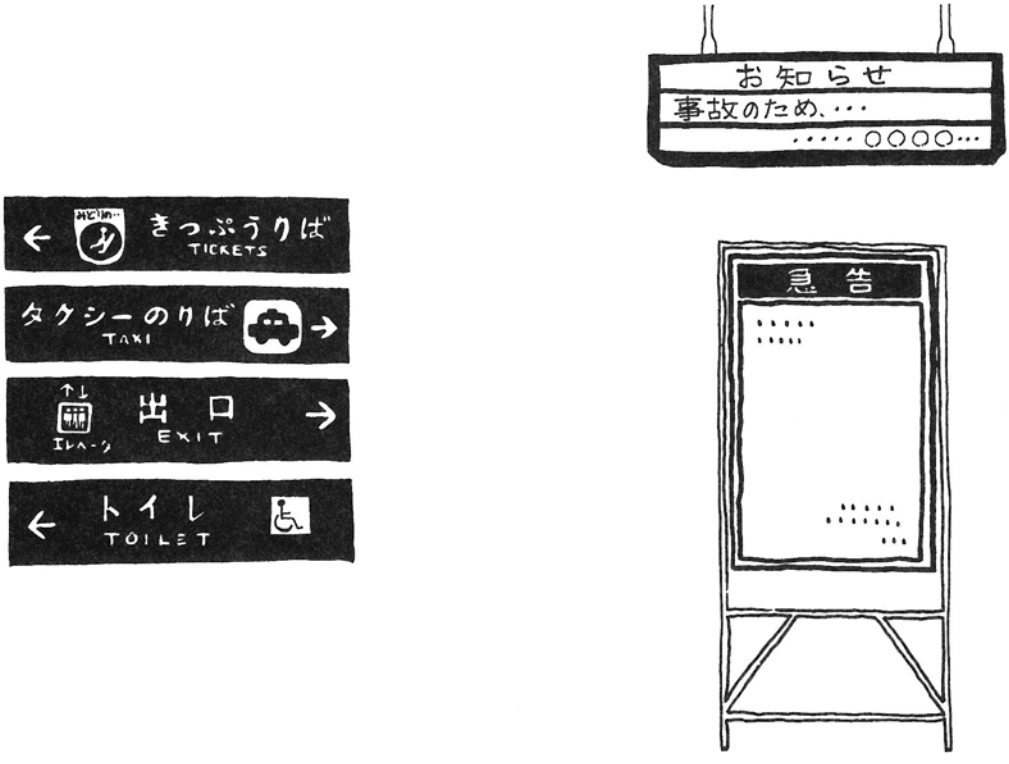

4. 建築物以外の路外駐車場

・路外駐車場の整備例

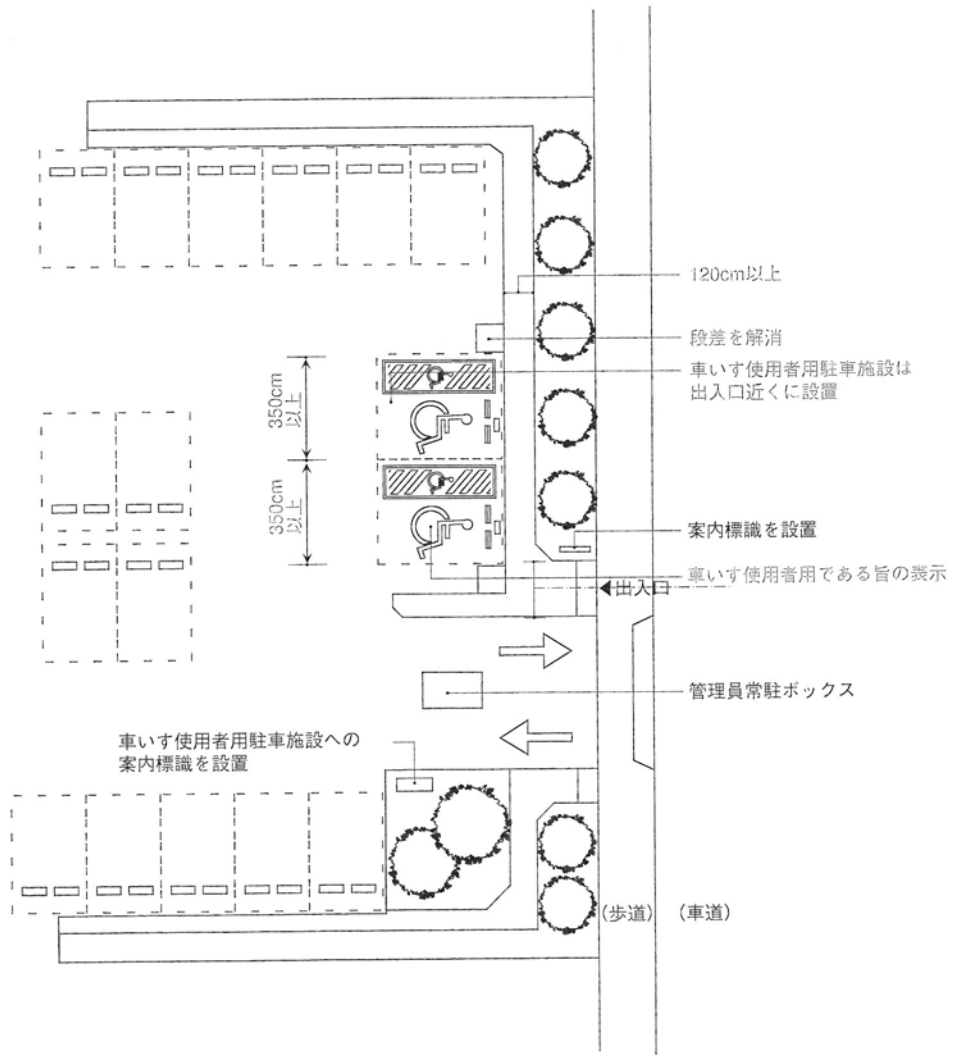

・車いす使用者用 駐車施設の標識の例



・駐車場の案内標識の例

